

Data Sheet



Article number: 604133040115

Description: Taper bored timing belt pulley
HTD 40 14M 115 TL 3020

Measures

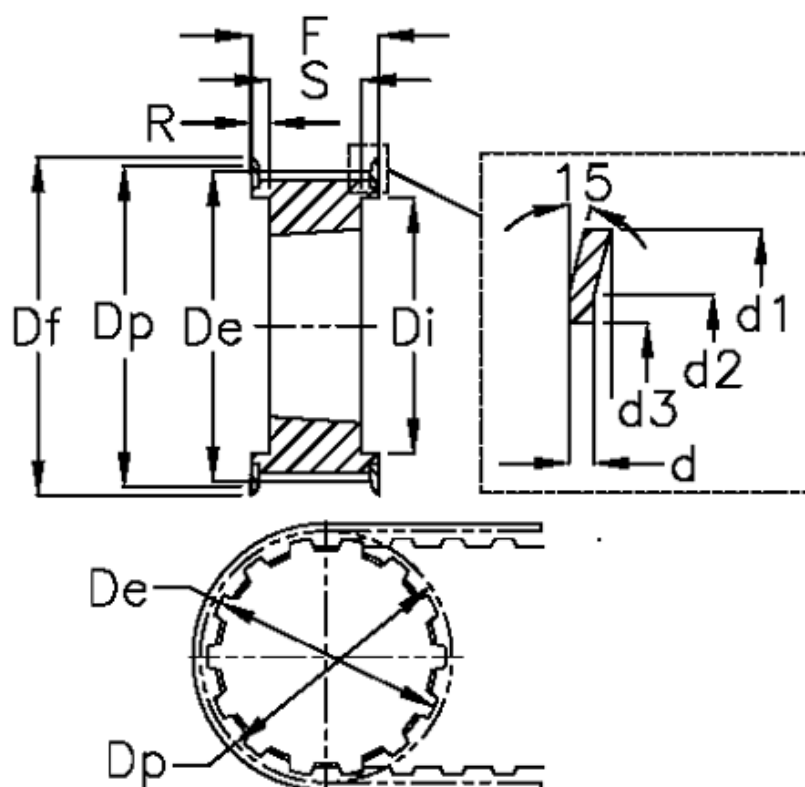

d = 2.5	F = 133	Weight = 9.2
d1 = 188	Flange type = F56	Width = 115
d2 = 176	For bushing = 3020	
d3 = 150	Max bore = 75	
De = 175.49	r = 41	
Df = 188	S = 51	
Di = 138	Tooth number = 40	
Dp = 178.25	Type = 14M	